

### Specification

Model		MVVA-10	MVVA-15	MVVA-20
Nozzle dia.		1.0 mm	1.5 mm	2.0 mm
Port size		G1/8	G1/4	G3/8
Medium		Air		
Operating pressure range		0.1~0.6 MPa		
Ambient temperature		0~+60℃ (No freezing)		
Final vacuum		-91.8 kPa (-690mmHg)		
Suction flow		32 ℓ/min	63 ℓ/min	130 ℓ/min
Air consumption		76 ℓ/min	100 ℓ/min	185 ℓ/min
Supply pressure		0.5 Mpa		
Signal setting range SJ type		-20.0 ~ -90 kPa (-150 ~ -680 mm Hg)		
Lubricator		Not required		
Weight	Standard type	84 g	126 g	294 g
	SJ type	110 g	158 g	321 g

### Symbol



### SJ

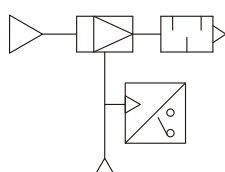

### Order example

**MVVA - 10 - SJ**

MODEL

NOZZLE DIA.

10: 1.0 mm  
15: 1.5 mm  
20: 2.0 mm

Blank: Standard type  
SJ: With adjustable switch

### Vacuum characteristics

#### MVVA-10

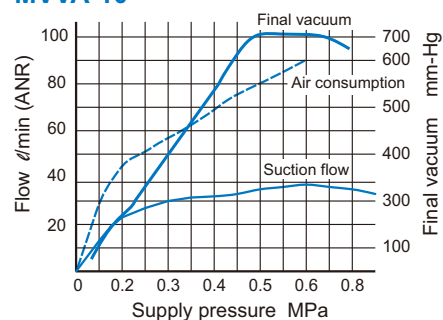

#### MVVA-15

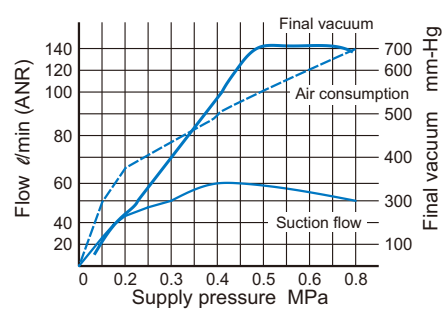

#### MVVA-20

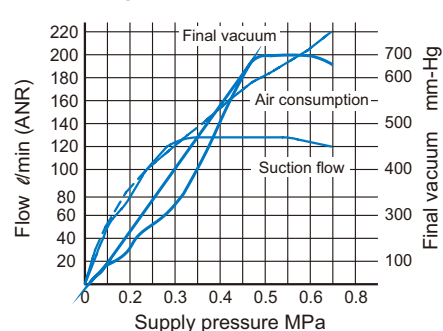

### MVVA-\*\*-\*\*

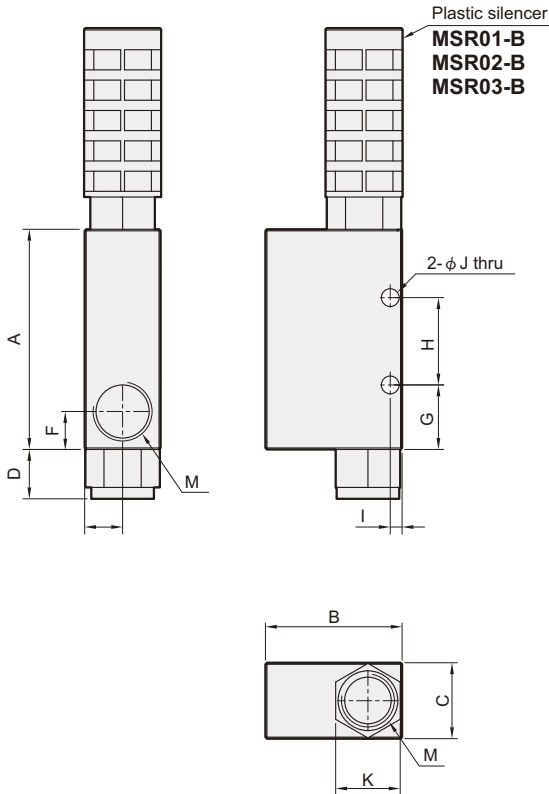

### MVVA-\*\*-SJ

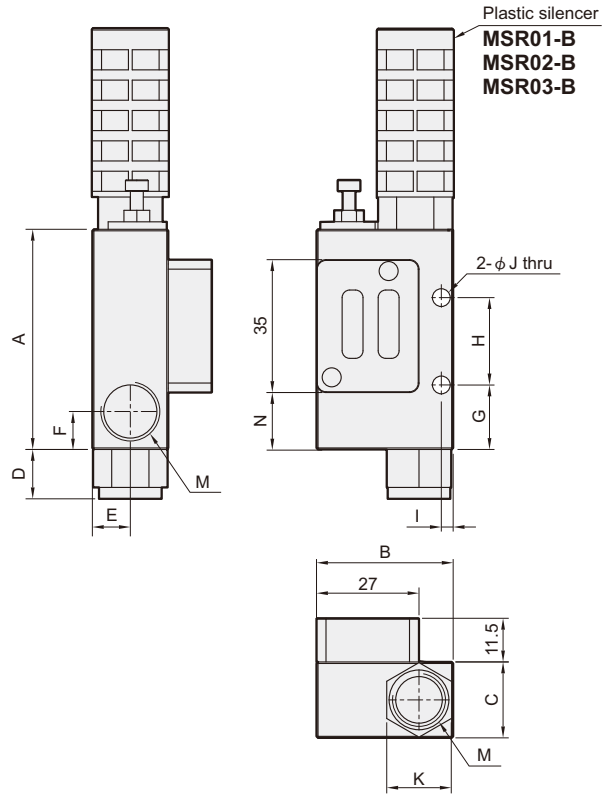

Code Model	A	B	C	D	E	F	G	H	I	J	K	N	M
MVVA-10	55	34	15.5	10	7.75	10	13	18	3	4.5	14	—	G1/8
MVVA-10-SJ	55	34	15.5	10	7.75	10	13	18	3	4.5	14	9	G1/8
MVVA-15	58	36	20	13	10	10	17	23	3	4.5	17	—	G1/4
MVVA-15-SJ	58	36	20	13	10	10	17	23	3	4.5	17	15	G1/4
MVVA-20	75	43	30	18	15	14	23	32	5	5.5	22	—	G3/8
MVVA-20-SJ	75	43	30	18	15	14	23	32	5	5.5	22	30.5	G3/8

### MSR\*-B

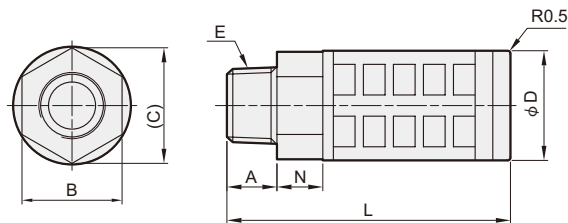

Model	A	B	C	D	E	L	N
MSR01-B	7	14	16.2	16	R1/8	33	7
MSR02-B	10	17	19.6	20.3	R1/4	63	8.5
MSR03-B	12	24	26.2	26.3	R3/8	67.5	11