

Specification

- DC 24V.
- 25 Pin D-sub connector (cable length 3m).
- Simple electric wire system.

Remark

- MVB-300, 460 series is available in 3-station ~ 12- station manifold.
- MVB-300, MVB-460 can not be installed with 5/3 valves.
- Individual manifold can be ordered. EX: MVB-220-5B5-G.
- 13-station ~ 20-station manifold can be offered as customised products and please contact sales people before ordering.
- Please contact sales people for the manifold for 3/2 valves.

Order example (Multi connector system)

MVB — 220 — 5B6 — SSSDC — G

MODEL

BODY WIDTH

220: for MVSC-220 series
300: for MVSC-300 series
460: for MVSC-460 series

MANIFOLD NUMBER
2, 3, 4, 5, 6, 7, 8, 9, 10, 11, 12

MANIFOLD

3B: 3 port (for body ported type)
5B: 5 port (for body ported type)

PORT THREAD

Blank: Rc thread
G: G thread
NPT: NPT thread

SOLENOID VALVE (for 5B)

S	4E1- 5/2 Single solenoid
D	4E2- 5/2 Double solenoid
C	4E2C- 5/3 Double solenoid
P	4E2P- 5/3 Double solenoid
R	4E2R- 5/3 Double solenoid

SOLENOID VALVE (for 3B)

C	3E1-NC- 3/2 Single solenoid/Normally closed
O	3E1-NO- 3/2 Single solenoid/Normally open
D	3E2- 3/2 Double Solenoid

※ Every double solenoid valve requires 2 stations on the manifold. (One is for the valve and another is for the adapter)

※ Valves are assembled from the left to the right.

Valves assembled

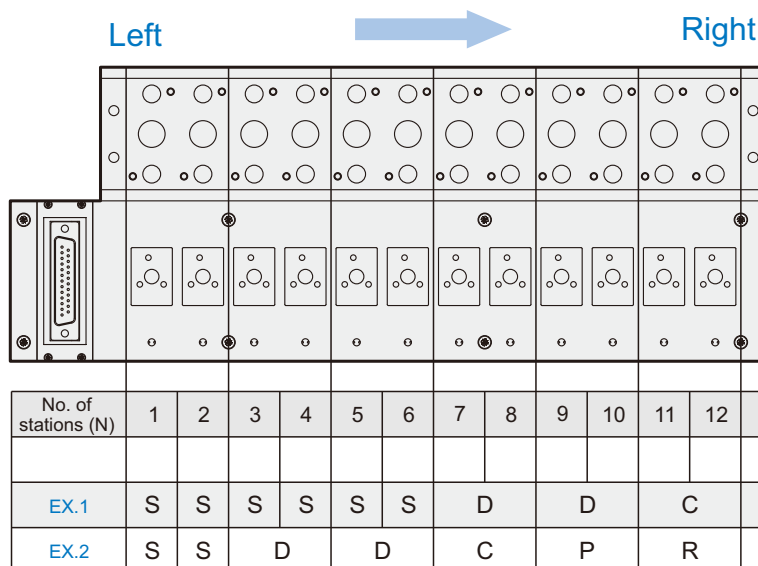

※ EX.1 5B12-SSSSSSDDC

※ EX.2 5B12-SSDDCPR

Order example (Solenoid valve)

MVSC – 220 – 4E2C – DC24 – N – G

MODEL

BODY WIDTH

220
300
460

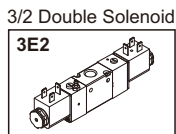
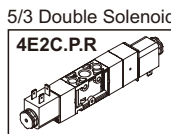
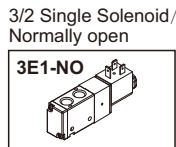
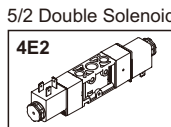
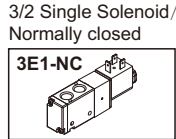
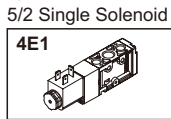

VOLTAGE N: No connector

PORT THREAD
Blank: Rc thread
G: G thread
NPT: NPT thread

Order example (Adapter for a double solenoid valve)

MVB – 220 – 5T

MODEL

BODY WIDTH

220: for MVSC-220 series
300: for MVSC-300 series
460: for MVSC-460 series

3T: Adapter for a 3-port
double solenoid valves.
5T: Adapter for a 5-port
double solenoid valves.

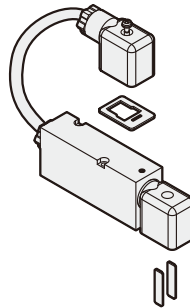

Ex

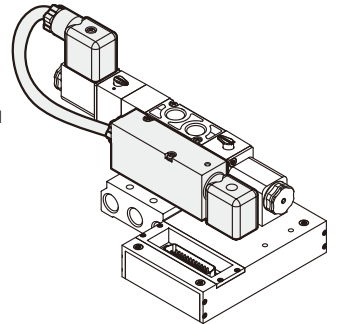

25 PIN

Wire color	Pin No.	Coil No.	
Brown	1	D-01	D-01
Brown / Black	2	D-02	D-02
Red	3	D-03	D-03
Red / Black	4	D-04	D-04
Orange	5	D-05	D-05
Orange / Black	6	D-06	D-06
Yellow	7	D-07	D-07
Yellow / Black	8	D-08	D-08
Green	9	D-09	D-09
Green / Black	10	D-10	D-10
Blue	11	D-11	D-11
Blue / Black	12	D-12	D-12
Purple / Black	14	D-13	D-13
Gray	15	D-14	D-14
Gray / Black	16	D-15	D-15
White	17	D-16	D-16
White / Black	18	D-17	D-17
Pink	19	D-18	D-18
Pink / Black	20	D-19	D-19
Light purple	21	D-20	D-20
Light purple / Black	22	D-21	D-21
Light blue	23	D-22	D-22
Light blue / Black	24	D-23	D-23
Purple	13	COM	COM
Light green	25	COM	COM

MVSC-220-4E2C.P.R

MVSC-220-4E2
MVSC-300-4E2
MVSC-460-4E2

MVSC-220-4E1
MVSC-300-4E1
MVSC-460-4E1

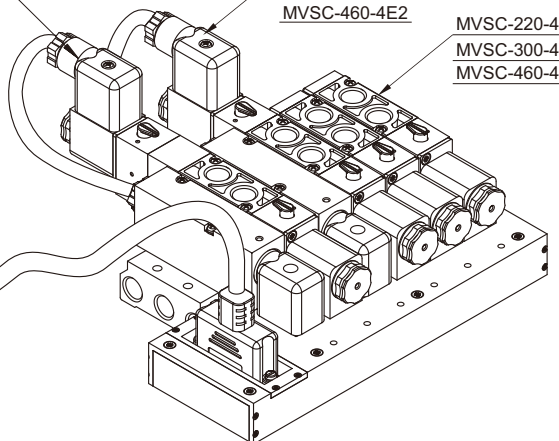

MVB-220 Dimensions

MULTI CONNECTOR SYSTEM



MVB-220-5B*

5 port (for body ported type)

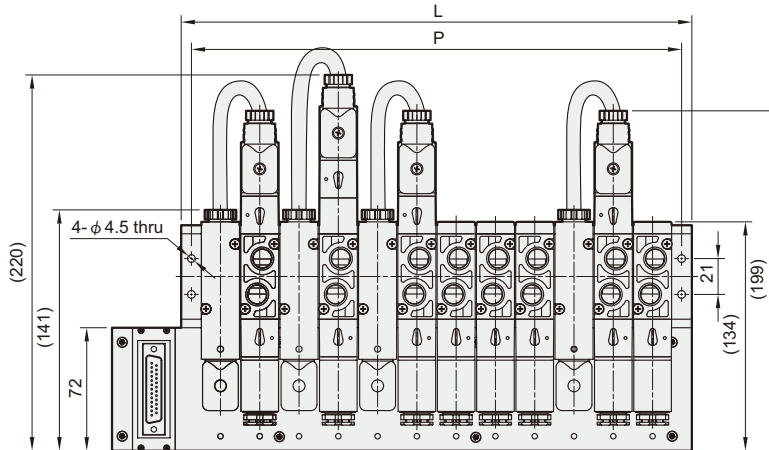

No. of stations	L	L1	P
2	69	109.5	57
3	92	132.5	80
4	115	155.5	103
5	138	178.5	126
6	161	201.5	149
7	184	224.5	172
8	207	247.5	195
9	230	270.5	218
10	253	293.5	241
11	276	316.5	264
12	299	339.5	287

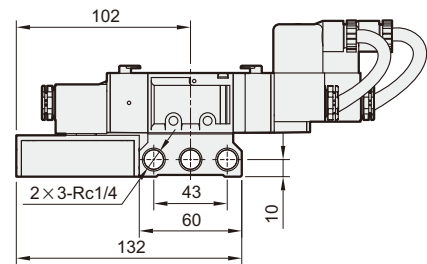
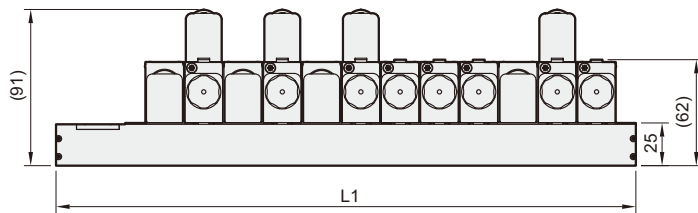

MVB-220-3B*

3 port (for body ported type)

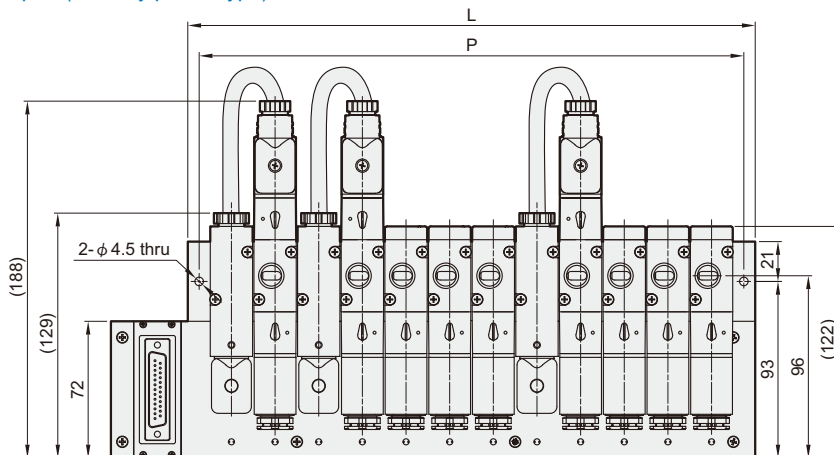

No. of stations	L	L1	P
2	69	109.5	57
3	92	132.5	80
4	115	155.5	103
5	138	178.5	126
6	161	201.5	149
7	184	224.5	172
8	207	247.5	195
9	230	270.5	218
10	253	293.5	241
11	276	316.5	264
12	299	339.5	287

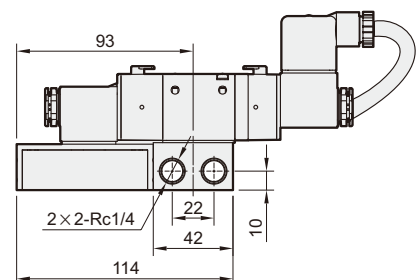
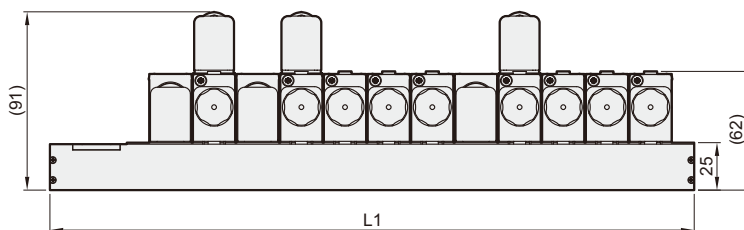

MVB-300 Dimensions

MULTI CONNECTOR SYSTEM



MVB-300-5B*

5 port (for body ported type)

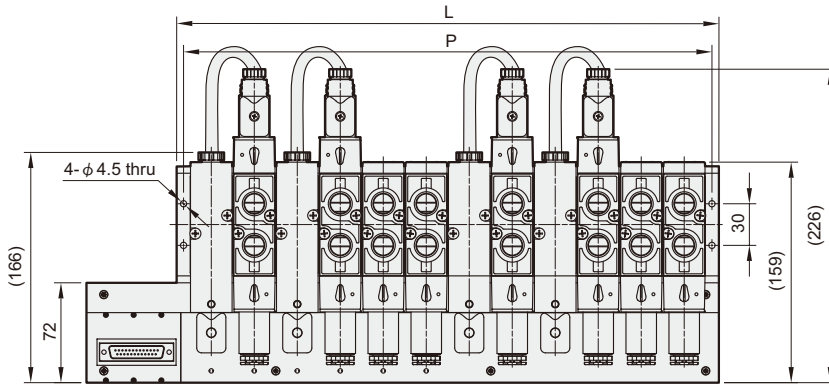

No. of stations	L	L1	P
3	112	177	102
4	143	208	133
5	174	239	164
6	205	270	195
7	236	301	226
8	267	332	257
9	298	363	288
10	329	394	319
11	360	425	350
12	391	456	381

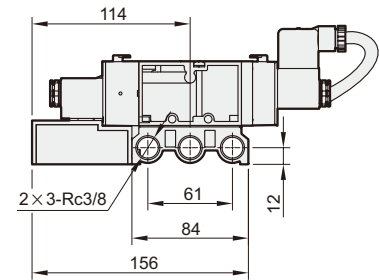
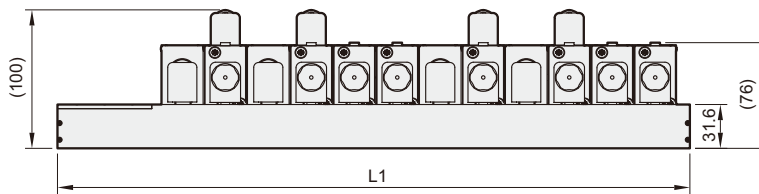

MVB-300-3B*

3 port (for body ported type)

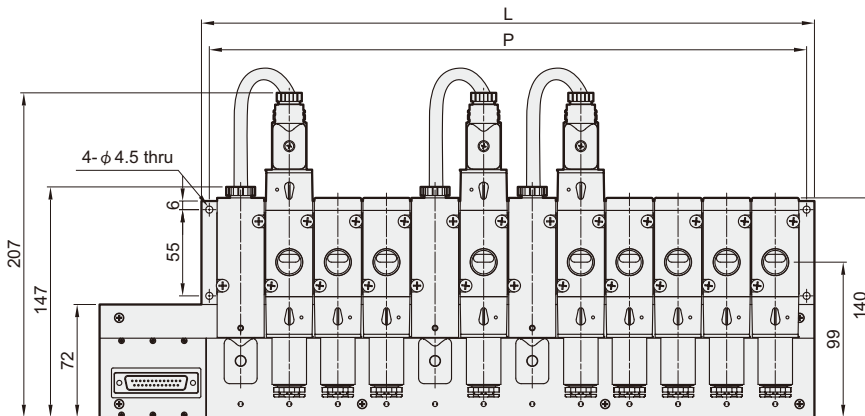

No. of stations	L	L1	P
3	112	177	102
4	143	208	133
5	174	239	164
6	205	270	195
7	236	301	226
8	267	332	257
9	298	363	288
10	329	394	319
11	360	425	350
12	391	456	381

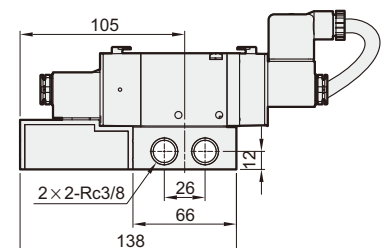
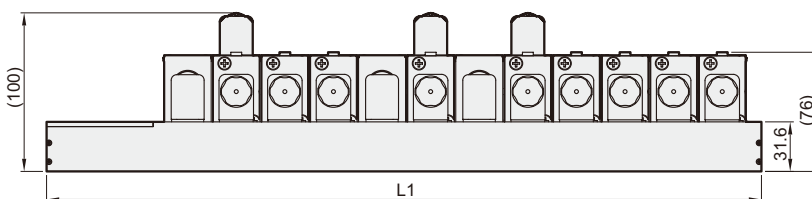

MVB-460 Dimensions

MULTI CONNECTOR SYSTEM



MVB-460-5B*

5 port (for body ported type)

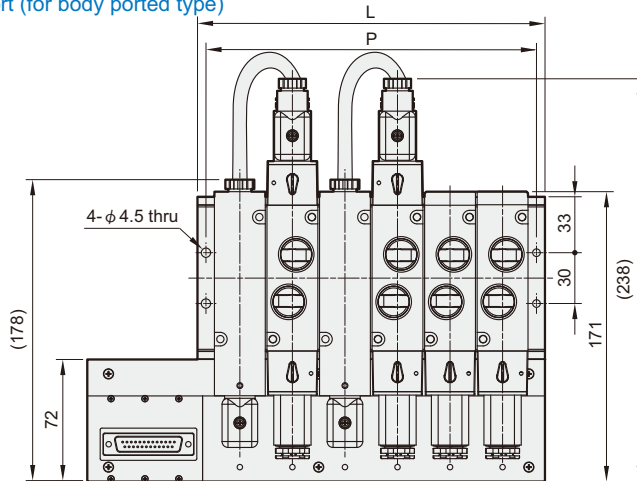

No. of stations	L	L1	P
3	112	177	102
4	143	208	133
5	174	239	164
6	205	270	195
7	236	301	226
8	267	332	257
9	298	363	288
10	329	394	319
11	360	425	350
12	391	456	381

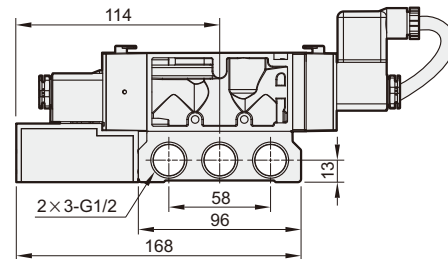
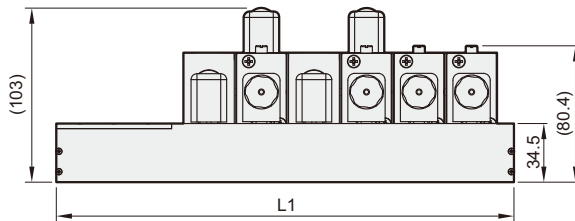

MVB-460-3B*

3 port (for body ported type)

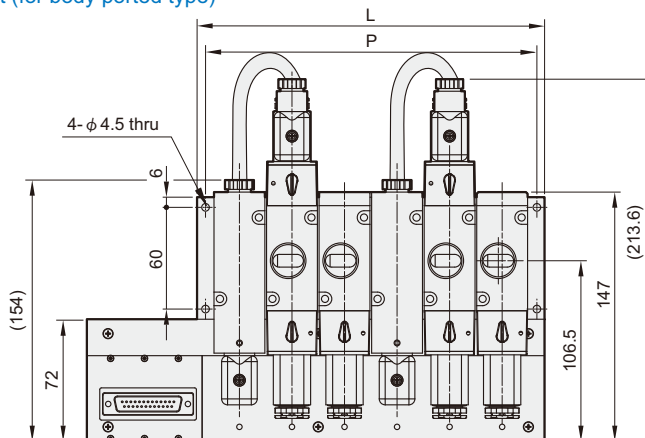

No. of stations	L	L1	P
3	112	177	102
4	143	208	133
5	174	239	164
6	205	270	195
7	236	301	226
8	267	332	257
9	298	363	288
10	329	394	319
11	360	425	350
12	391	456	381

