

MAIR200 series

AIR UNIT (PRECISION REGULATOR)



mindman



Symbol

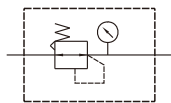

Specification

Model	MAIR200
Bore No.	8A
Port size	1/4
Medium	Air
Max. operating pressure	1 MPa
Min. operating pressure	Setting pressure + 0.05 MPa
Proof pressure	1.5 MPa
Regulated pressure range	2K: 0.005~0.2 MPa
	4K: 0.01~0.4 MPa
	8K: 0.01~0.8 MPa
Sensitivity	Within 0.2% of full span
Repeatability	Within ± 0.5% of full span
Air consumption (※)	4.4 ℓ/min(ANR) or less
Ambient temperature	-5~+60°C (No freezing)
Attachment	Bracket
Option	Pressure gauge (PG-40S)
Weight	300g

Order example

MAIR200 - 8A - 2K - C - □

MODEL

BORE SIZE

8A: 1/4

PRESSURE RANGE

2K: 0.005~0.2 MPa
4K: 0.01~0.4 MPa
8K: 0.01~0.8 MPa

PRESSURE GAUGE (PG-40S)

PORT THREAD

Blank: Rc thread
G: G thread
NPT: NPT thread

※ For supply pressure 1 MPa.

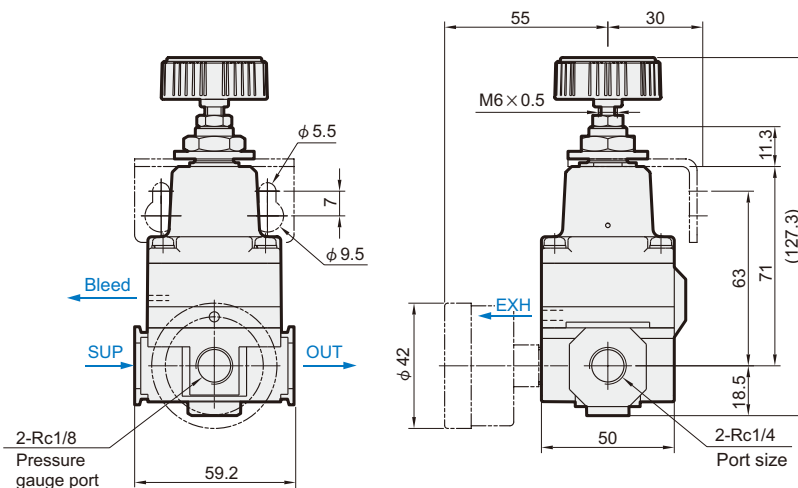
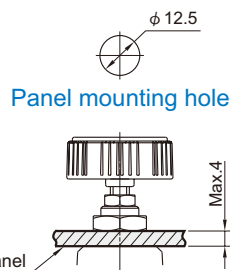
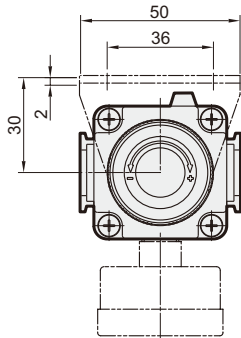

Flow feature

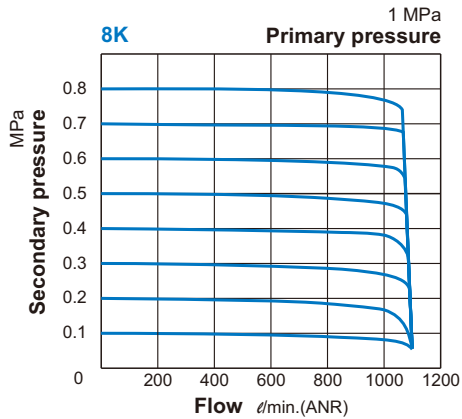
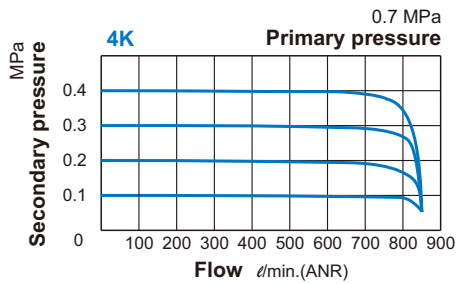
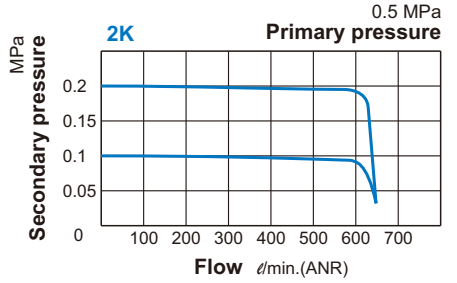

Relief characteristics

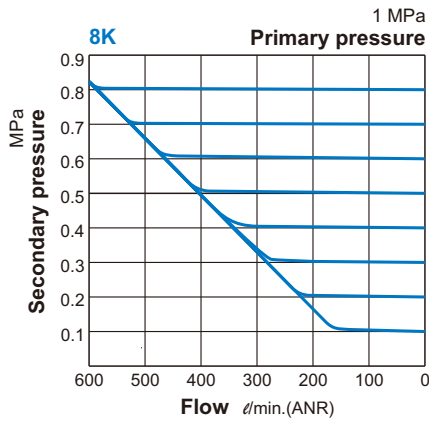
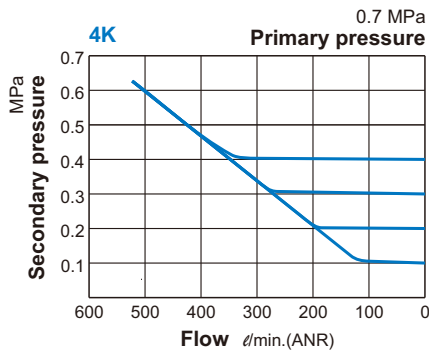
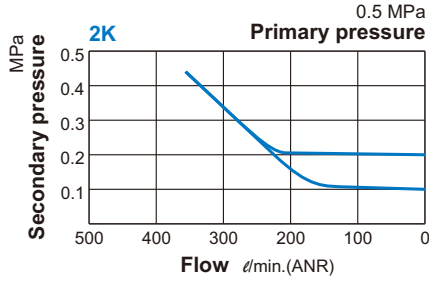

Pressure characteristics

